

FRBDS02.99

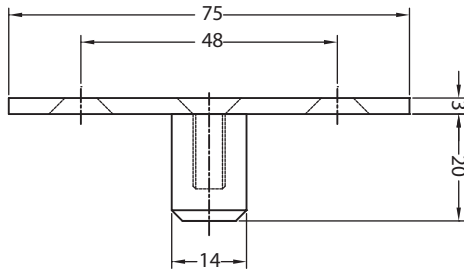

Oberer Zapfen für obere Türschiene FRP02
Bovendraaispil voor bovenplint FRP02

FRP02B

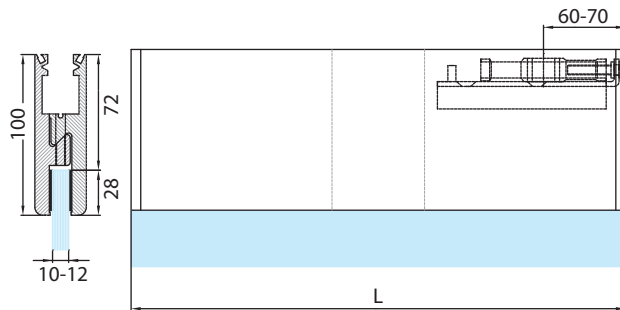
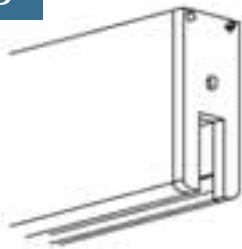

Referenties / Referenties

Obere Türschiene 100 mm mit Einsatz und Endstücken,
Montage mit unsichtbaren Schrauben
Bovenplint met hoogte 100 mm met inzetstuk
en einkappen, montageschroeven niet zichtbaar



Für 10 mm Glas
Voor glas van 10 mm

FRP02B/10.12

FRP02B/10.15

FRP02B/10.36



Für 12 mm Glas
Voor glas van 12 mm

FRP02B/12.12

FRP02B/12.15

FRP02B/12.36

FRP02BL

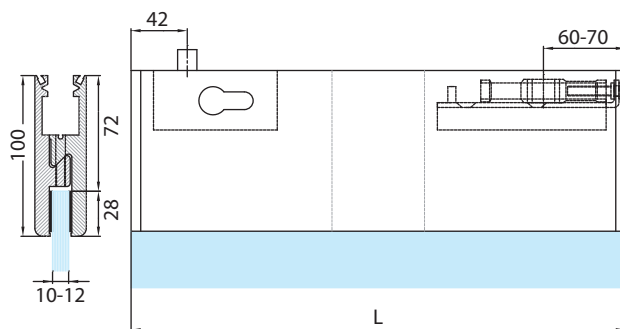
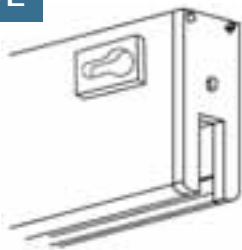

Referenties / Referenties

Obere Türschiene 100 mm mit Einsatz, Endstücken,
Schloss und Zylinder, Montage mit unsichtbaren Schrauben
Bovenplint met hoogte 100 mm met inzetstuk
en einkappen, met slot en cilinder



Für 10 mm Glas
Voor glas van 10 mm

FRP02BL/10.12

FRP02BL/10.15

FRP02BL/10.36



Für 12 mm Glas
Voor glas van 12 mm

FRP02BL/12.12

FRP02BL/12.15

FRP02BL/12.36

FRP020

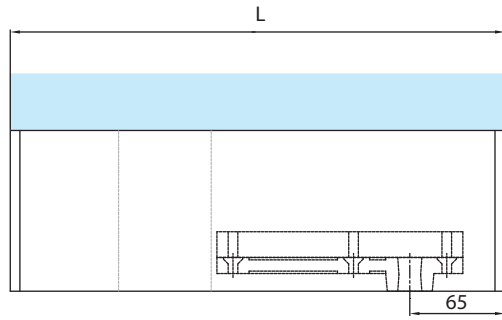
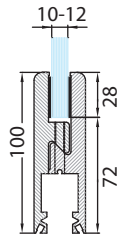
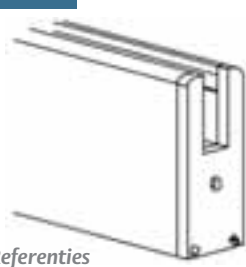

Referenties / Referenties



Oberer Türschiene 100 mm mit italienischem viereckigem Einsatz und Endstücken, Montage mit unsichtbaren Schrauben
Onderplint met hoogte 100 mm met Italiaans, vierkant inzetstuk en eindakpen, montageschroeven niet zichtbaar



Alu. eloxiert silber gebürstet
Geanodiseerd alu. natuurkleur



Edelstahl gebürstet
Geborsteld roestvrij staal



Alu. eloxiert edelstahllähnlich Aninox
Geanodiseerd alu. Aninox



Für 10 mm Glas
Voor glas van 10 mm

FRP020/10.12

FRP020/10.15

FRP020/10.36



Für 12 mm Glas
Voor glas van 12 mm

FRP020/12.12

FRP020/12.15

FRP020/12.36

FRP020L

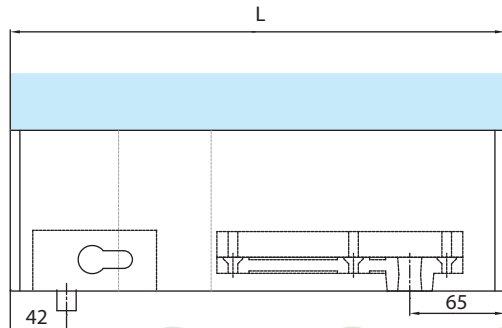
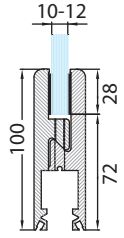
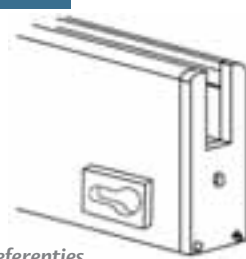

Referenties / Referenties



Untere Türschiene 100 mm mit Einsatz, Endstücken, Schloss und Zylinder, Montage mit unsichtbaren Schrauben
Onderplint met hoogte 100 mm met Italiaans, vierkant inzetstuk en eindakpen, met slot en cilinder



Alu. eloxiert silber gebürstet
Geanodiseerd alu. natuurkleur



Edelstahl gebürstet
Geborsteld roestvrij staal



Alu. eloxiert edelstahllähnlich Aninox
Geanodiseerd alu. Aninox



Für 10 mm Glas
Voor glas van 10 mm

FRP020L/10.12

FRP020L/10.15

FRP020L/10.36



Für 12 mm Glas
Voor glas van 12 mm

FRP020L/12.12

FRP020L/12.15

FRP020L/12.36

FRP07B

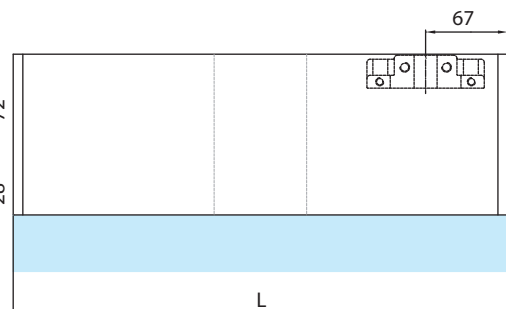
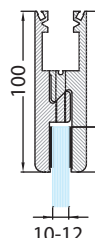
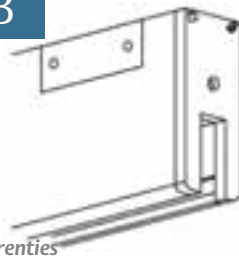

Referenties / Referenties

Obere Türschiene 100 mm mit Einsatz für integrierten Türschließer der Reihe 5600-5750 und mit Endstücken, Montage mit unsichtbaren Schrauben

Bovenplint met hoogte 100 mm met inzetstuk voor ingebouwde kozijndorpelveer van reeks 5600-5750, eindakpen, montageschroeven niet zichtbaar



Alu. eloxiert silber gebürstet
Geanodiseerd alu. natuurkleur



Alu. eloxiert edelstahllähnlich Aninox
Geanodiseerd alu. Aninox



Für 10 mm Glas
Voor glas van 10 mm

FRP07B/10.12

FRP07B/10.36



Für 12 mm Glas
Voor glas van 12 mm

FRP07B/12.12

FRP07B/12.36

FRP07BL

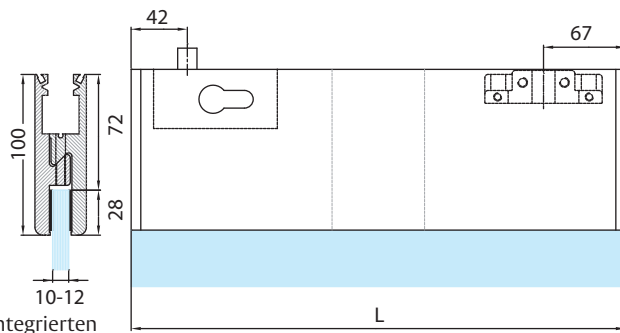

Referenties / Referenties

Obere Türschiene 100 mm mit Einsatz für integrierten Türschließer der Reihen 5600-5750 mit Endstücken, Schloss und Zylinder, Montage mit unsichtbaren Schrauben
Bovenplint met hoogte 100 mm met inzetstuk voor ingebouwde kozijnorpelveer van reeks 5600-5750, einkappen, met slot en cilinder

Alu. eloxiert silber gebürstet
Geanodiseerd alu. natuurkleur

Alu. eloxiert edelstahlnählich Aninox
Geanodiseerd alu. Aninox



Für 10 mm Glas
Voor glas van 10 mm

FRP07BL/10.12

FRP07BL/10.36



Für 12 mm Glas
Voor glas van 12 mm

FRP07BL/12.12

FRP07BL/12.36

FRP06B

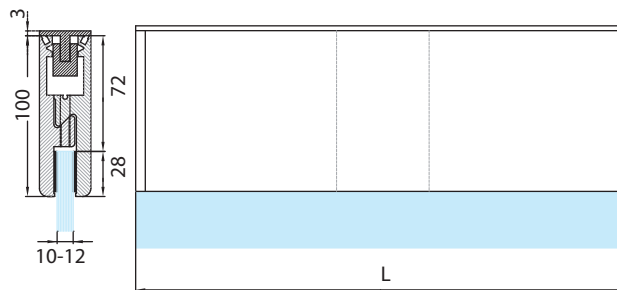
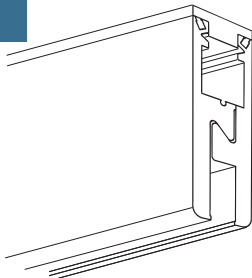

Referenties / Referenties

Obere Türschiene 100 mm ohne Endstücke für Festteile + oberes Ausgleichsprofil 3 mm
Bovenplint hoogte 100 mm voor vaste panelen + opvulprofiel van 3 mm, zonder einkappen

Alu. eloxiert silber gebürstet
Geanodiseerd alu. natuurkleur

Edelstahl gebürstet
Geborsteld roestvrij staal

Alu. eloxiert edelstahlnählich Aninox
Geanodiseerd alu. Aninox



Für 10 mm Glas
Voor glas van 10 mm

FRP06B/10.12

FRP06B/10.15

FRP06B/10.36



Für 12 mm Glas
Voor glas van 12 mm

FRP06B/12.12

FRP06B/12.15

FRP06B/12.36

FRP06O

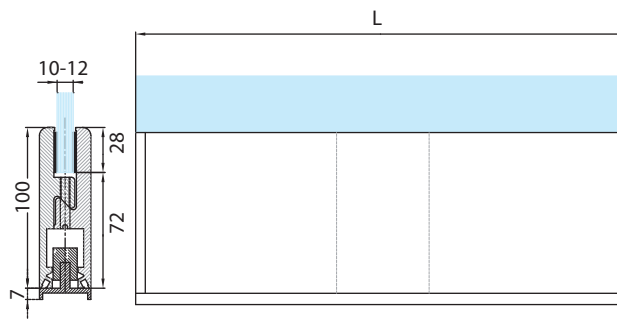
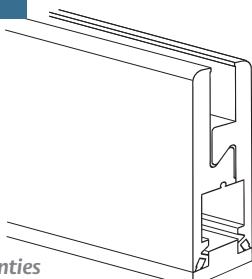

Referenties / Referenties

untere Türschiene 100 mm ohne Endstücke für Festteile + unteres Ausgleichsprofil 7 mm
Onderplint hoogte 100 mm voor vaste panelen + opvulprofiel onderaan van 7 mm, zonder einkappen

Alu. eloxiert silber gebürstet
Geanodiseerd alu. natuurkleur

Edelstahl gebürstet
Geborsteld roestvrij staal

Alu. eloxiert edelstahlnählich Aninox
Geanodiseerd alu. Aninox



Für 10 mm Glas
Voor glas van 10 mm

FRP06O/10.12

FRP06O/10.15

FRP06O/10.36



Für 12 mm Glas
Voor glas van 12 mm

FRP06O/12.12

FRP06O/12.15

FRP06O/12.36

FRE14.99

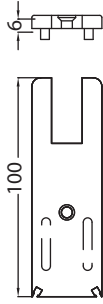

Referenties / Referenties

Schwarzer Einsatz mit Schraube
Zwarte kunststof eindstuk met schroef

FRB**

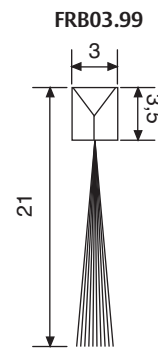
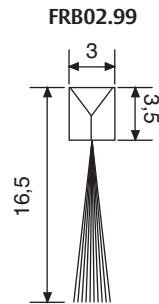
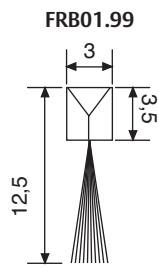
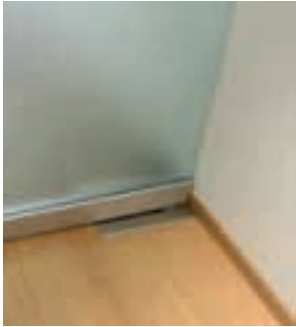

Referenties / Referenties

Bürstendichtung, Länge 2 m, für 7 mm Spiel
Afdichtborstel lengte 2 m voor speling van 7 mm

FRB01.99

Bürstendichtung, Länge 2 m, für 9 mm Spiel
Afdichtborstel lengte 2 m voor speling van 9 mm

FRB02.99

Bürstendichtung, Länge 2 m, für 13 mm Spiel
Afdichtborstel lengte 2 m voor speling van 13 mm

FRB03.99

