

Türschlösser *Kruksloten*

LAGUNE

Technische Merkmale

- Montage auf Glasausschnitt 64A
- Beidseitig verwendbar
- Profilylinder mit Stiftzuhaltung DIN (Norm DIN 18254)
- Fallenrückzug per Schlüssel
- Für Türen aus Einscheibensicherheitsglas von 8 mm Dicke
- Für 10 mm starke ESG-Türblätter bestellen Sie eine Referenz S229.81.0 (4 Dichtungen von 1mm), nicht für 4300.30.4, 4300.31.4, 4309.30.4, 4309.31.4
- Schlüsselverriegelung mit Fallenvorschub
- Kombinationen mit Generalschlüssel möglich
- Lieferung mit einem flachen Schließblech und 3 Schlüsseln

Algemene technische eigenschappen

- Montage op 64A-uitsparing
- Omkeerbaar
- Europrofielcilinder (norm DIN 18254)
- Intrekken van de dagschoot met sleutel
- Voor gehard glas van 8 mm
- Voor gehard glas van 10 mm, bijkomend te bestellen referentie S229.81.0 (set van 4 pakkingen van 1 mm)
- Uitgezonderd voor de kruksloten referenties 4300.30.4 / 4300.31.4 / 4309.30.4 / 4309.31.4
- Vergrendeling met sleutel door voorwaartse beweging van de schoot
- Sleutelcombinaties met master key mogelijk
- Geleverd met slotplaat en 3 sleutels

EXTRAS

DE PRODUCTVOORDELEN

Elegantes Design

TÜV-geprüft

In vielen Varianten

Beidseitig
verwendbar

Design

TÜV-gecertificeerd

Versillende
varianten

Omkeerbaar

4300

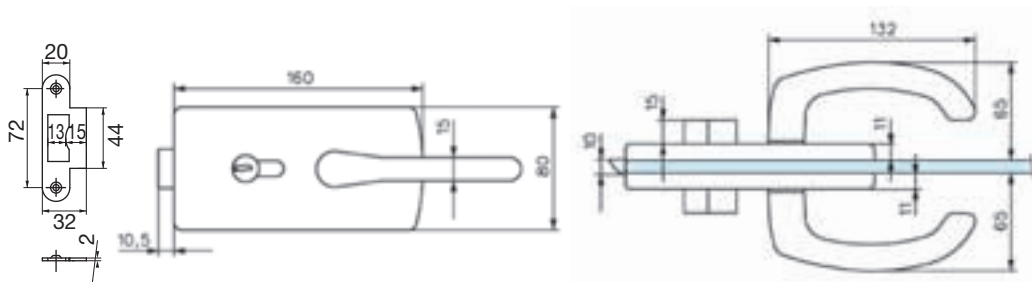
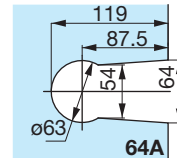

Referenzen / Referenties

Mittelschloss mit Profilylinder
und zwei Drückern

Middenslot met Europrofielcilinder
en krukken



Messing poliert
Gepolijst messing



Glanz verchromt
Glanzend chrom



Matt verchromt
Mat chrom



Vergoldet
Verguld



Pulverbeschichtet weiß 9010
Wit gelakt 9010



4300.00.0

4300.30.0

4300.31.0

4300.40.0

4300.51.0



4300.30.4

4300.31.4

4350

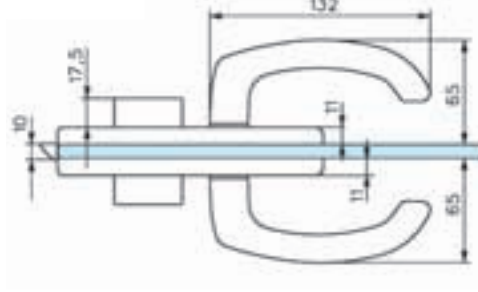
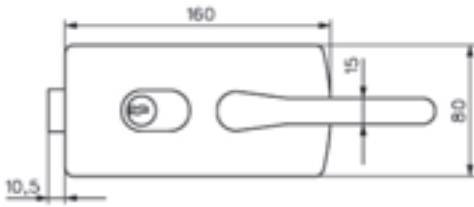
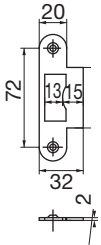
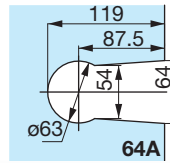

Türschlösser
und Bänder
Kruksloten en
scharnieren

Referenzen / Referenties



Glanz verchromt
Glanzend chroom



Matt verchromt
Mat chroom



Vergoldet
Verguld

Mittelschloss mit Profilzylinder und zwei Drückern
Middenslot met Europrofielcilinder met beveiligingsrozetten en krukken

4350.30.0

4350.31.0

4350.40.0

4309.**.0

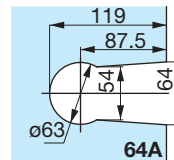

Referenzen / Referenties

Gegenkasten (Schließblech) für die
Türschlossreihen 4300-4310-4350
Tegenslotkast voor middensloten
van 4300-4310-4350



Messing poliert
Gepolijst messing



Glanz verchromt
Glanzend chroom



Matt verchromt
Mat chroom



Vergoldet
Verguld



Pulverbeschichtet weiß 9010
Wit gelakt 9010



4309.00.0

4309.30.0

4309.31.0

4309.40.0

4309.51.0



4309.30.4

4309.31.4

0309



Schließblech mit Anschlag
für die Türschlossreihen 4300-4310-4350
Slotplaat met aanslag voor middensloten
van reeksen 4300-4310-4350

0309.30.0

0309.31.0

4306

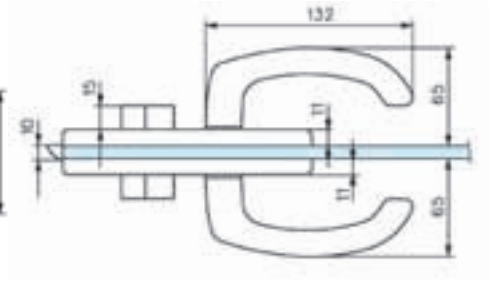
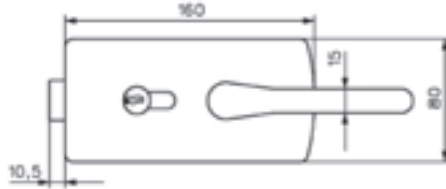
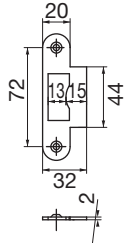
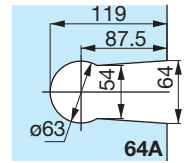

Referenzen / Referenties



Messing poliert
Gepolijst messing



Glanz verchromt
Glanzend chroom



Matt verchromt
Mat chroom

4306.00.0

4306.30.0

4306.31.0

Mittelschloss mit Profilzylinder und Drückern,
Verriegelung ohne Fallenvorschub

Middenslot met Europrofielcilinder en krukken,
vergrendeling door blokkering van de schoot

4301

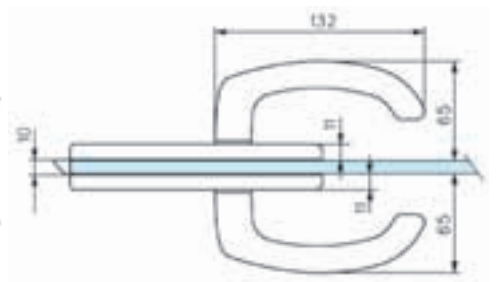
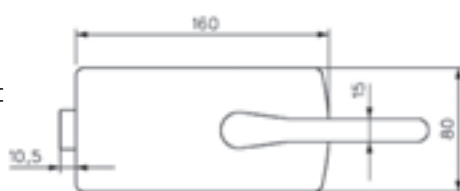
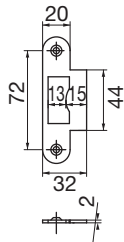
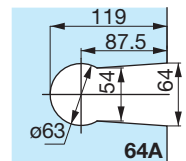

Referenzen / Referenties



Messing poliert
Gepolijst messing



Glanz verchromt
Glanzend chroom



Matt verchromt
Mat chroom



Vergoldet
Verguld



Pulverbeschichtet weiß 9010
Wit gelakt 9010

4301.00.0

4301.30.0

4301.31.0

4301.40.0

4301.51.0

Mittelschloss mit Falle
und zwei Drückern

Middenslot met enkel dagschoot en krukken

4307

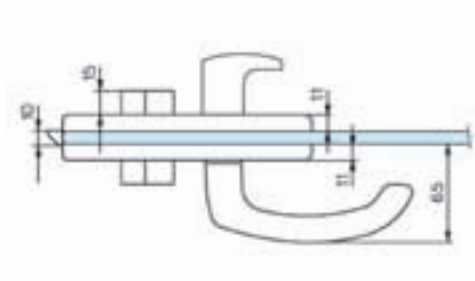
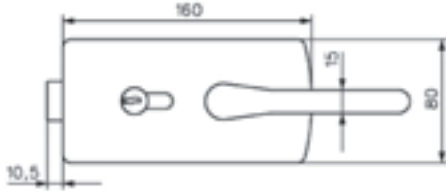
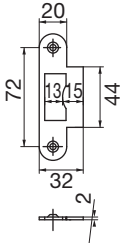
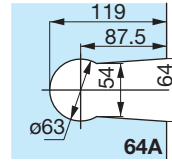

Referenzen / Referenties



Messing poliert
Gepolijst messing

4307.00.0



Glanz verchromt
Glanzend chroom

4307.30.0



Matt verchromt
Mat chroom

4307.31.0

Mittelschloss mit Profilzylinder und Drücker Innen und festem Knopf Außen, Verriegelung ohne Fallenvorschub
Middenslot met Europrofielcilinder met kruk aan de binnenkant / vaste knop aan de buitenkant, vergrendeling door blokkering van de schoot

4310

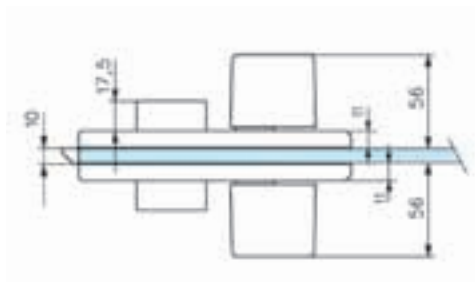
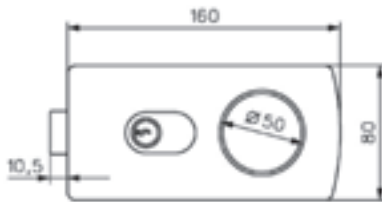
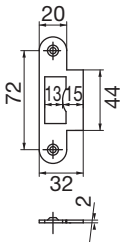
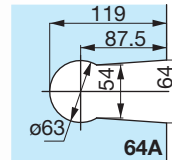

Referenzen / Referenties



Glanz verchromt
Glanzend chroom

4310.30.0



Matt verchromt
Mat chroom

4310.31.0



Vergoldet
Verguld

4310.40.0

Mittelschloss mit Profilzylinder und Drehknöpfen, mit Zylinderrosetten
Middenslot met Europrofielcilinder met beveiligingsrosetten en knoppen

Türschlösser
und Bänder
Kruksloten en
scharnieren

4311

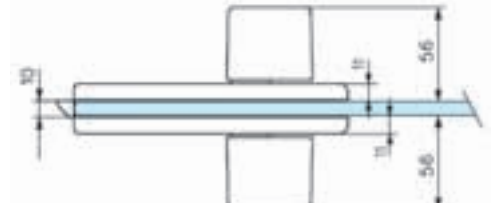
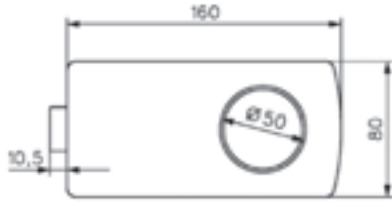
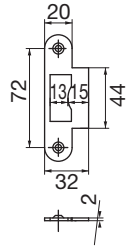
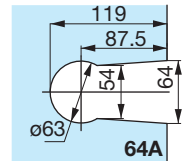

Referenzen / Referenties



Glanz verchromt
Glanzend chrom



Matt verchromt
Mat chrom



Verguldet
Verguld

Mittelschloss mit Falle und Drehknöpfen
Middenslot met dagschoot en deurknoppen

4311.30.0

4311.31.0

4311.40.0

4312

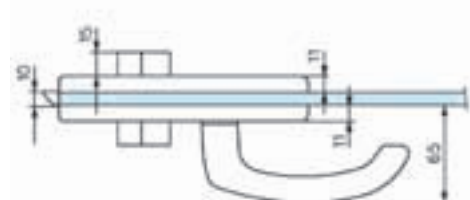
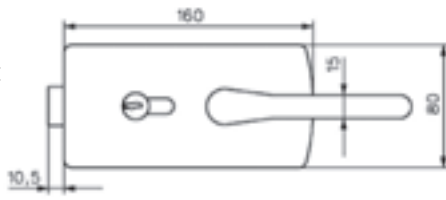
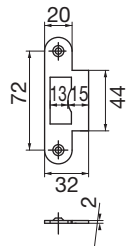
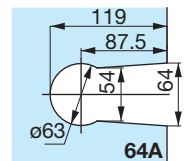

Referenzen / Referenties



Glanz verchromt
Glanzend chrom



Matt verchromt
Mat chrom

Mittelschloss mit Profilzylinder und einem Drücker Innen
Middenslot met Europrofielcilinder met enkele kruk aan de binnenzijde

4312.30.0

4312.31.0

4314

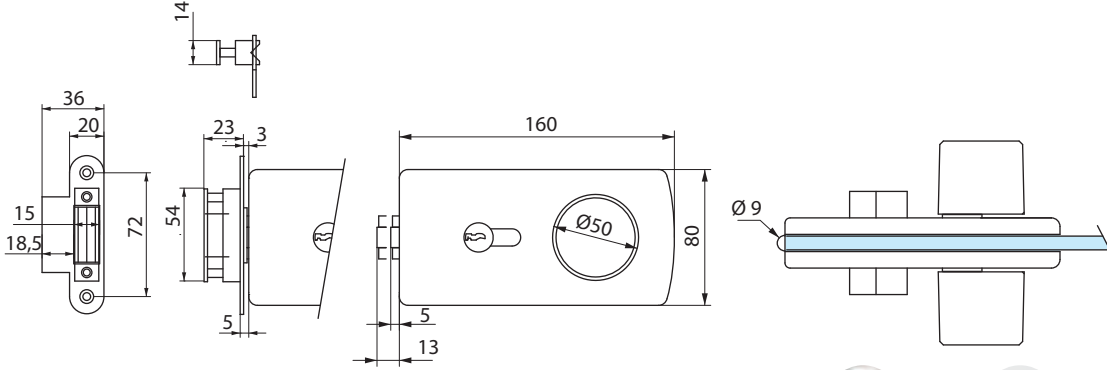
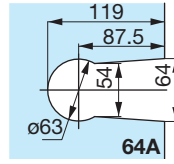

Referenzen / Referenties



Mittelschloss mit Profilzylinder, Rollfalle und festen Türknoöpfen
 Middenslot met rolsnapslot en Europrofielcilinder met vaste knoppen



4314.30.0 4314.31.0

4309.**.1

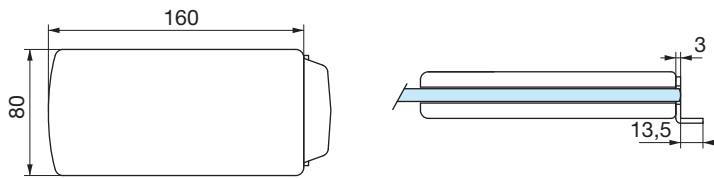
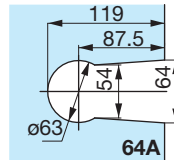

Referenzen / Referenties



Gegenkasten (Schließblech) für Türschlossreihe 4314
 Tegenslotkast voor middenslot reeks 4314

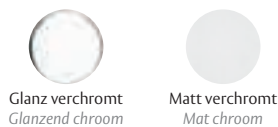

4309.30.1 4309.31.1

Türschlösser
 und Bänder
 Kruksloten en
 scharnieren

4360.0BT

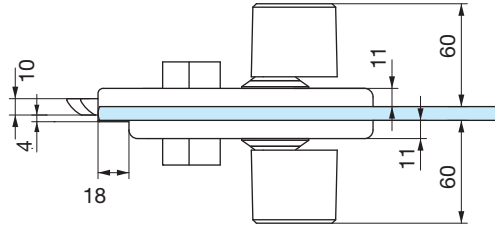
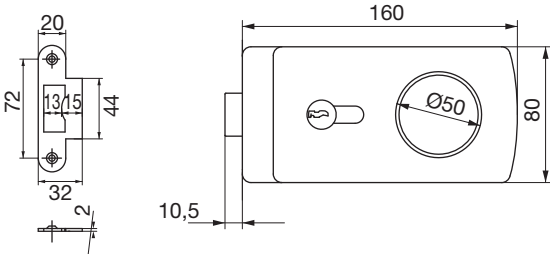
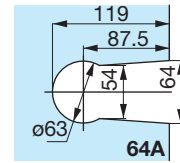

Referenzen / Referenties



Glanz verchromt
Glanzend chroom



Matt verchromt
Mat chroom



Pulverbeschichtet weiß 9010
Wit gelakt 9010

Versetzt angebrachtes Zylinderschloss mit Drehknöpfen, mittig sitzende Falle
Middenslot met ingekorte rugplaat met Europrofielcilinder en paar knoppen

4360.30.0BT

4360.31.0BT

4360.51.0BT

- Die versetzt angebrachte Abdeckkappe sorgt für den Kontakt mit dem Falzboden und schafft eine kontinuierliche Abdichtung in Schloßhöhe.

- De ingekorte rugplaat laat een perfecte afdichting over de totale hoogte van de deur toe.

4361.0BT

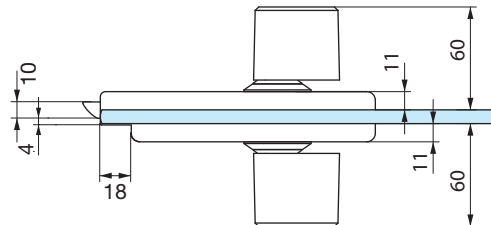
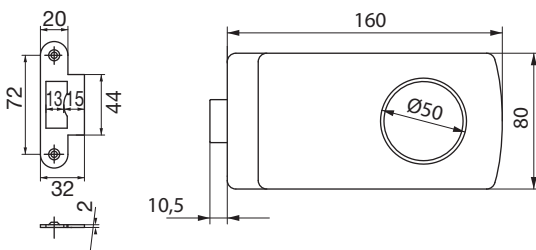
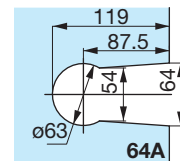

Referenzen / Referenties



Glanz verchromt
Glanzend chroom



Matt verchromt
Mat chroom



Pulverbeschichtet weiß 9010
Wit gelakt 9010

Versetzt angebrachtes Fallenschloss mit 2 Drehknöpfen
Middenslot met ingekorte rugplaat en paar knoppen

4361.30.0BT

4361.31.0BT

4361.51.0BT

- Die versetzt angebrachte Abdeckkappe sorgt für den Kontakt mit dem Falzboden und schafft eine kontinuierliche Abdichtung in Schloßhöhe.

- De ingekorte rugplaat laat een perfecte afdichting over de totale hoogte van de deur toe.

Türschlösser
und Bänder
Kruksloten en
scharnieren

Türschlösser
und Bänder
Kruksloten en
scharnieren

4363.0E*T

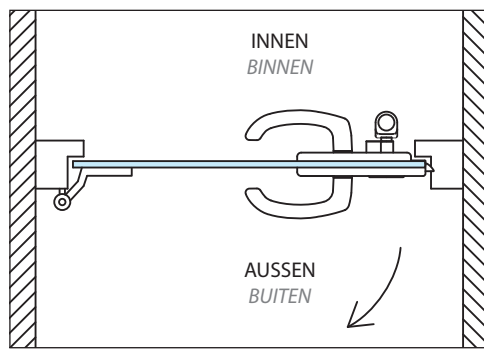
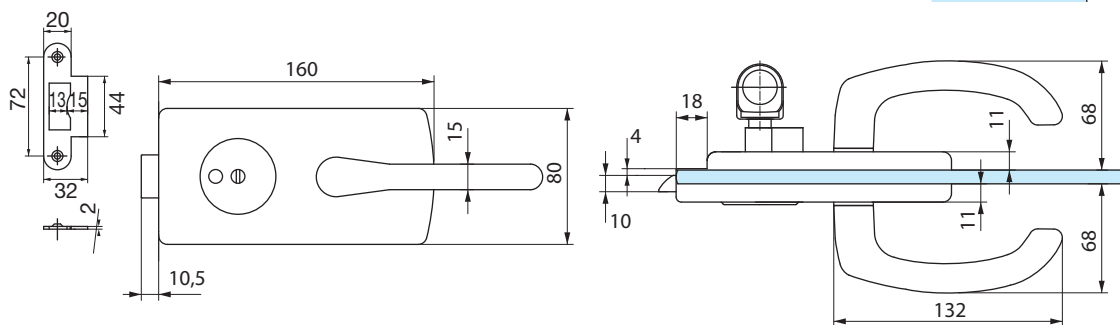
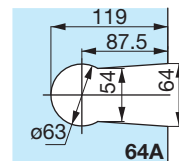

Referenzen / Referenties



Messing poliert
Gepolijst messing



Glanz verchromt
Glanzend chroom



Matt verchromt
Mat chroom

Schloss mit Besetztanzeige, Türöffnung außen, rechts ziehend DIN links

Middenslot met ingekorte rugplaat met vrij-bezet aanduiding en paar krukken DIN links

4363.00.0EDT

4363.30.0EDT

4363.31.0EDT

• Die versetzt angebrachte Abdeckkappe sorgt für den Kontakt mit dem Falzboden und schafft eine kontinuierliche Abdichtung in Schloßhöhe.

• De ingekorte rugplaat laat een perfecte afdichting over de totale hoogte van de deur toe.

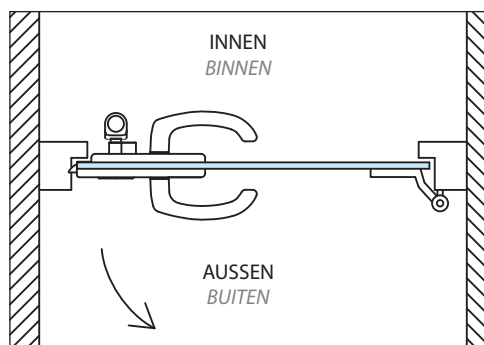

Referenzen / Referenties



Messing poliert
Gepolijst messing



Glanz verchromt
Glanzend chroom



Matt verchromt
Mat chroom

Schloss mit Besetztanzeige, Türöffnung außen, links ziehend DIN rechts

Middenslot met ingekorte rugplaat met vrij-bezet aanduiding en paar krukken DIN rechts

4363.00.0EGT

4363.30.0EGT

4363.31.0EGT

• Die versetzt angebrachte Abdeckkappe sorgt für den Kontakt mit dem Falzboden und schafft eine kontinuierliche Abdichtung in Schloßhöhe.

• De ingekorte rugplaat laat een perfecte afdichting over de totale hoogte van de deur toe.

4363.01*P

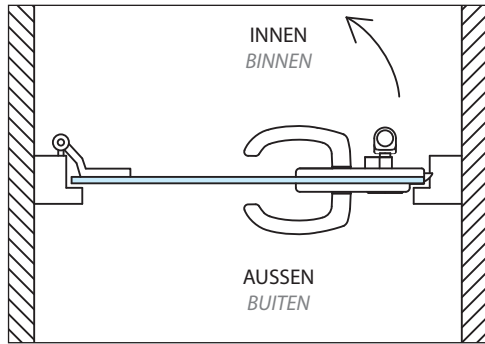
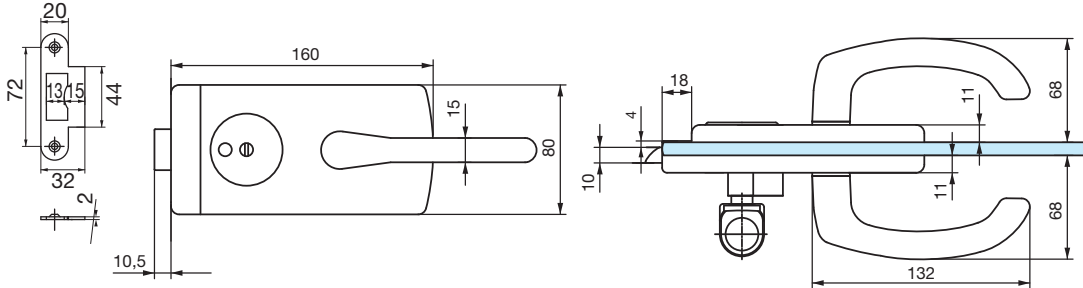
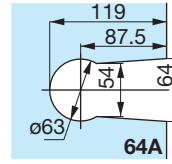

Referenzen / Referenties



Messing poliert
Gepolijst messing



Glanz verchromt
Glanzend chroom



Matt verchromt
Mat chroom

Schloss mit Besetztanzeige, Türöffnung innen, rechts drückend DIN rechts
Middenslot met ingekorte rugplaat met vrij-bezet aanduiding en paar krukken DIN rechts

4363.00.0IDP

4363.30.0IDP

4363.31.0IDP

- Die versetzt angebrachte Abdeckkappe sorgt für den Kontakt mit dem Falzboden und schafft eine kontinuierliche Abdichtung in Schloßhöhe.

- De ingekorte rugplaat laat een perfecte afdichting over de totale hoogte van de deur toe.

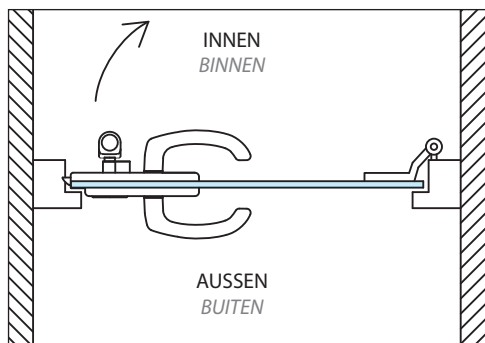

Referenzen / Referenties



Messing poliert
Gepolijst messing



Glanz verchromt
Glanzend chroom



Matt verchromt
Mat chroom

Schloss mit Besetztanzeige, Türöffnung innen, links drückend DIN links
Middenslot met ingekorte rugplaat met vrij-bezet aanduiding en paar krukken DIN links

4363.00.0IGP

4363.30.0IGP

4363.31.0IGP

- Die versetzt angebrachte Abdeckkappe sorgt für den Kontakt mit dem Falzboden und schafft eine kontinuierliche Abdichtung in Schloßhöhe.

- De ingekorte rugplaat laat een perfecte afdichting over de totale hoogte van de deur toe.

Türschlösser
und Bänder
Kruksloten en
scharnieren

4367.0**

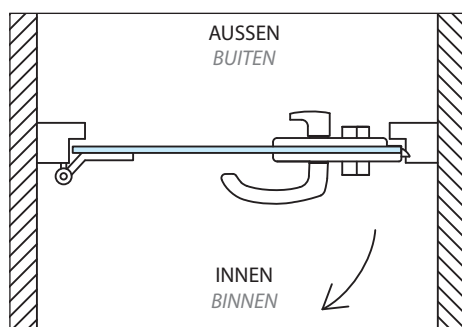
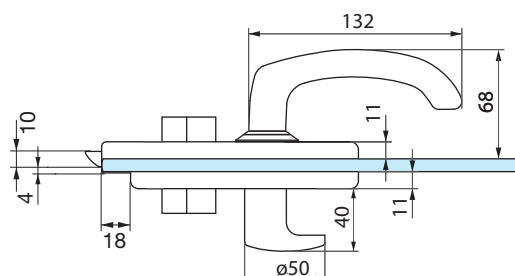
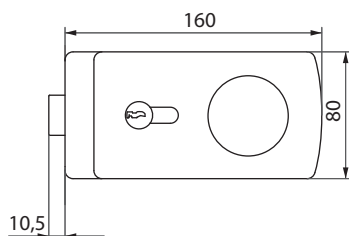
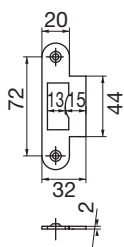
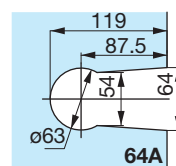

EXTRAS

DE PRODUCTVOORDELEN

Versetzt
angebrachte
Abdeckkappe
Ingekorte rugplaat

Referenzen / Referenties



Versetzt angebrachtes Mittelschloss mit Profilzylinder und Drücker Innen und festem Türkнопf auf der Außenseite, Verriegelung ohne Fallenvorschub Din Links
Middenslot met ingekorte rugplaat met Europrofielcilinder met vaste knop aan buitenzijde en kruk aan binnenzijde, DIN links, vergrendeling door blokkering van de schoot Din Links

• Die versetzt angebrachte Abdeckkappe sorgt für den Kontakt mit dem Falzboden und schafft eine kontinuierliche Abdichtung in Schloßhöhe.

• De ingekorte rugplaat laat een perfecte afdichting over de totale hoogte van de deur toe.



Glanz verchromt
Glanzend chroom



Matt verchromt
Mat chroom

4367.30.0AD

4367.31.0AD

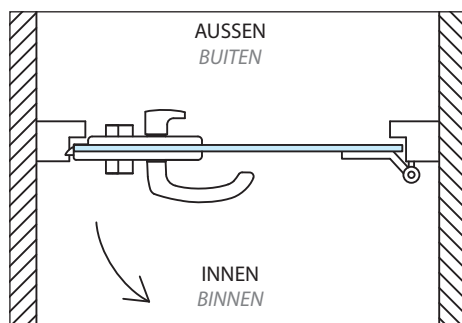

Referenzen / Referenties



Versetzt angebrachtes Mittelschloss mit Profilzylinder und Drücker Innen und festem Türkнопf auf der Außenseite, Verriegelung ohne Fallenvorschub Din rechts
Middenslot met ingekorte rugplaat met Europrofielcilinder met vaste knop aan buitenzijde en kruk aan binnenzijde, DIN rechts, vergrendeling door blokkering van de schoot Din rechts

• Die versetzt angebrachte Abdeckkappe sorgt für den Kontakt mit dem Falzboden und schafft eine kontinuierliche Abdichtung in Schloßhöhe.

• De ingekorte rugplaat laat een perfecte afdichting over de totale hoogte van de deur toe.



Glanz verchromt
Glanzend chroom



Matt verchromt
Mat chroom

4367.30.0BC

4367.31.0BC

4366

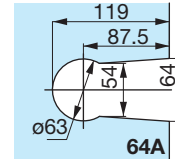

Türschlösser
und Bänder
Kruksloten en
scharnieren

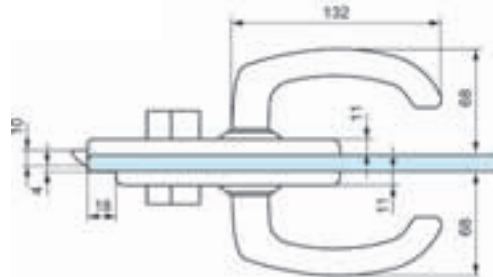
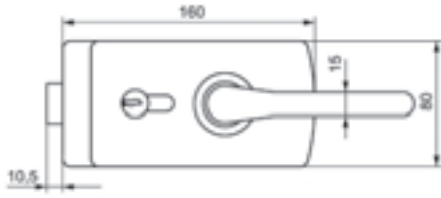
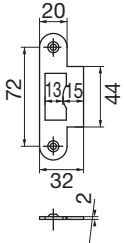

Referenzen / Referenties



Matt verchromt
Mat chroom

Versetzt angebrachtes Mittelschloss mit Profilzylinder und Drückern, Verriegelung ohne Fallenvorschub.

4366.31.0

Middenslot met ingekorte rugplaat met Europrofielcilinder en paar krukken, vergrendeling door blokkering van de schoot

• Die versetzt angebrachte Abdeckkappe sorgt für den Kontakt mit dem Falzboden und schafft eine kontinuierliche Abdichtung in Schloßhöhe.

• De ingekorte rugplaat laat een perfecte afdichting over de totale hoogte van de deur toe.



In vielen Varianten
Verschillende varianten

4380

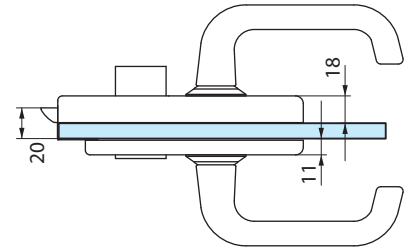
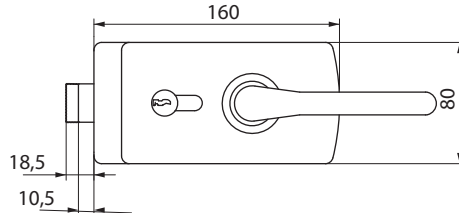
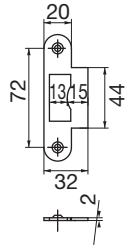
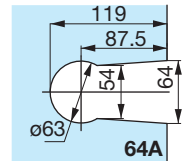

Referenzen / Referenties

Versetzt angebrachtes Mittelschloss mit Profilzylinder und Drückern, nicht mittig sitzende Falle, Verriegelung ohne Fallenvorschub.

Middenslot met ingekorte rugplaat met Europrofielcilinder en paar krukken, excentrische schoot, vergrendeling door voorwaartse beweging van de schoot



Glanz verchromt
Glanzend chroom



Matt verchromt
Mat chroom



Pulverbeschichtet weiß 9010
Wit gelakt 9010



4380.30.0

4380.31.0

4380.51.0



4380.31.4

- Die versetzt angebrachte Abdeckkappe sorgt für den Kontakt mit dem Falzboden und schafft eine kontinuierliche Abdichtung in Schloßhöhe.

- De ingekorte rugplaat laat een perfecte afdichting over de totale hoogte van de deur toe.

4381

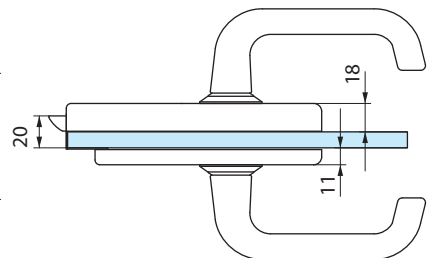
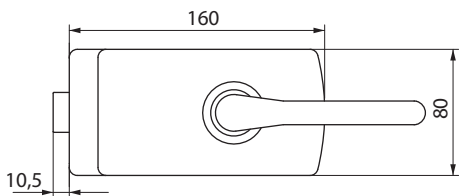
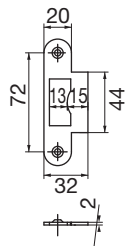
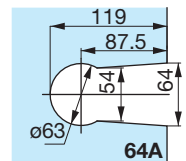

Referenzen / Referenties

Versetzt angebrachtes Mittelschloss mit Falle und Drückern, nicht mittig sitzende Falle, Verriegelung ohne Fallenvorschub.

Middenslot met ingekorte rugplaat en paar krukken, excentrische schoot.



Glanz verchromt
Glanzend chroom



Matt verchromt
Mat chroom



Pulverbeschichtet weiß 9010
Wit gelakt 9010



4381.30.0

4381.31.0

4381.51.0

- Die versetzt angebrachte Abdeckkappe sorgt für den Kontakt mit dem Falzboden und schafft eine kontinuierliche Abdichtung in Schloßhöhe.

- De ingekorte rugplaat laat een perfecte afdichting over de totale hoogte van de deur toe.

4389

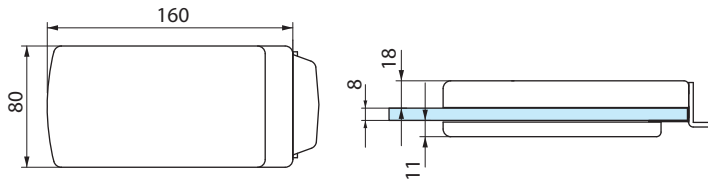
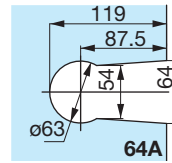

Türschlösser
und Bänder
Kruksloten en
scharnieren

Referenzen / Referenties



Gegenkasten (Schließblech) für Türschlossreihe 4380
Tegenslotkast voor middensloten reeks 4380



Glanz verchromt
Glanzend chroom



Matt verchromt
Mat chroom

4389.30.0

4389.31.0

